

# Replacement Parts

Issue Date: 12/2023

## CONTENTS

- 2 STARSsystem
- 5 IR System
- 6 ArmSure
- 7 *MR Safe* Overhead Arm Support
- 8 Antegrade IR Platform
- 8 Drape Support
- 9 Retrograde IR Platform
- 10 Lower Leg Support
- 11 Prone Support
- 12 Clinician Arm Support
- 13 *MR Safe* Adducted Arm Scoop
- 14 Head Immobiliser

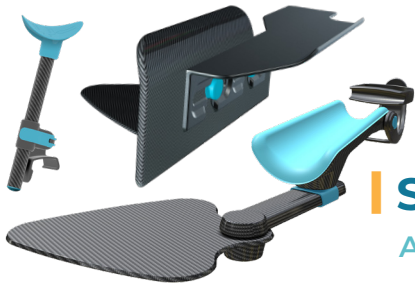

# STARSystem

AM0160- AM0100 - AM0140

## Component Codes

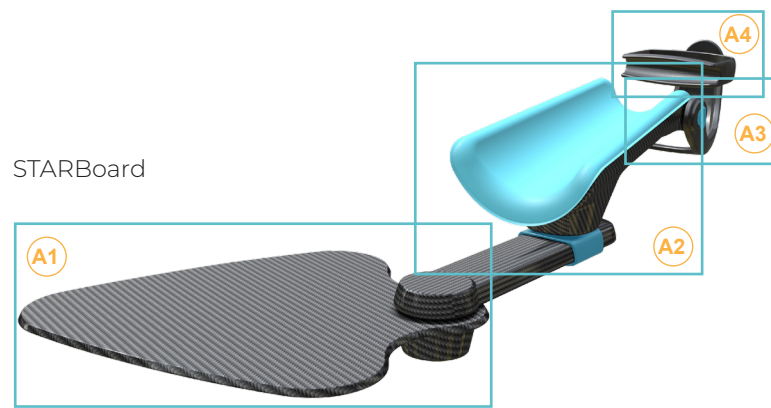

BC STARTable

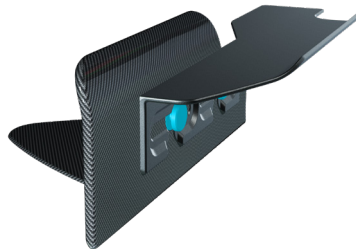

D STARSupport



## STARBoard

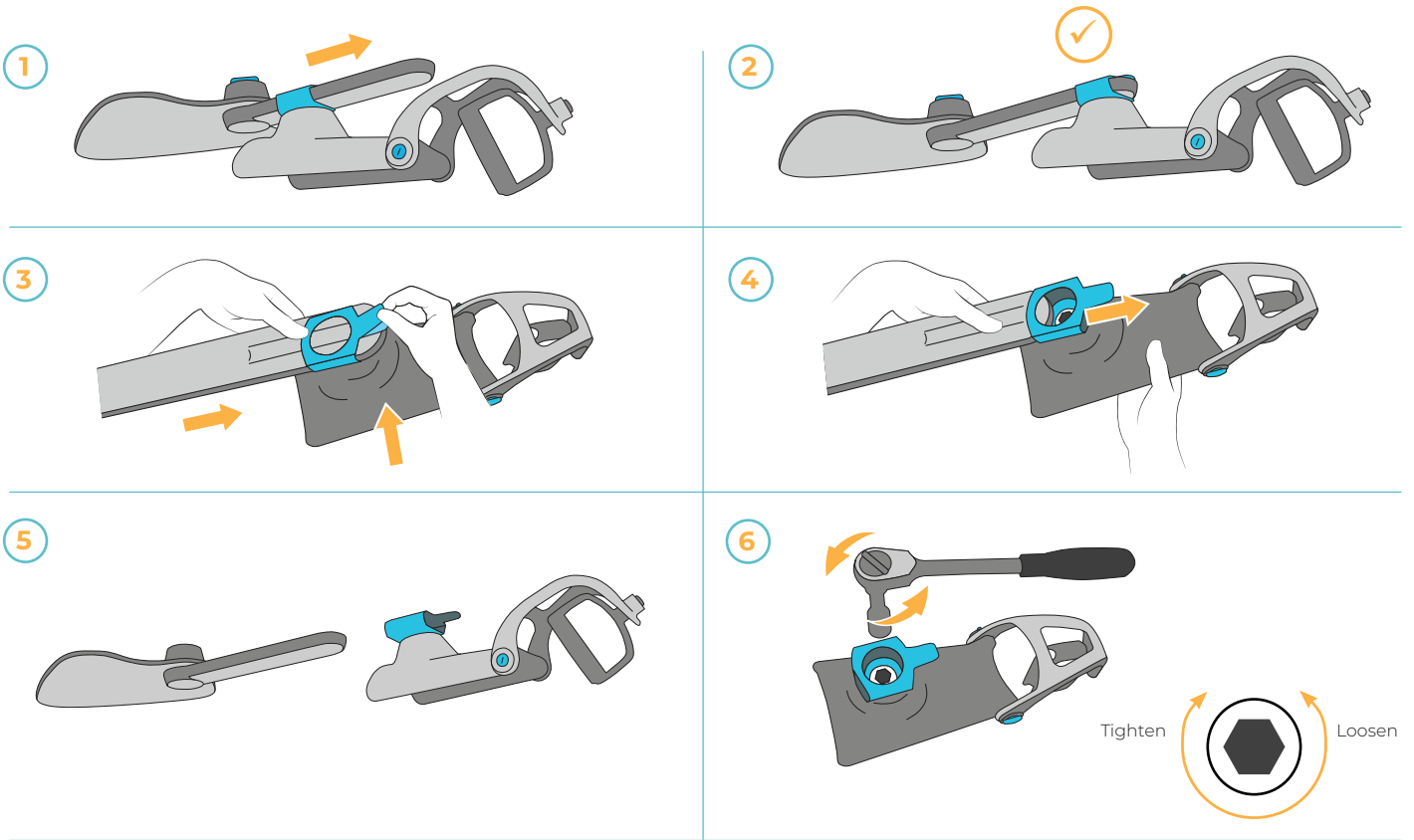

## STARBoard Component Codes

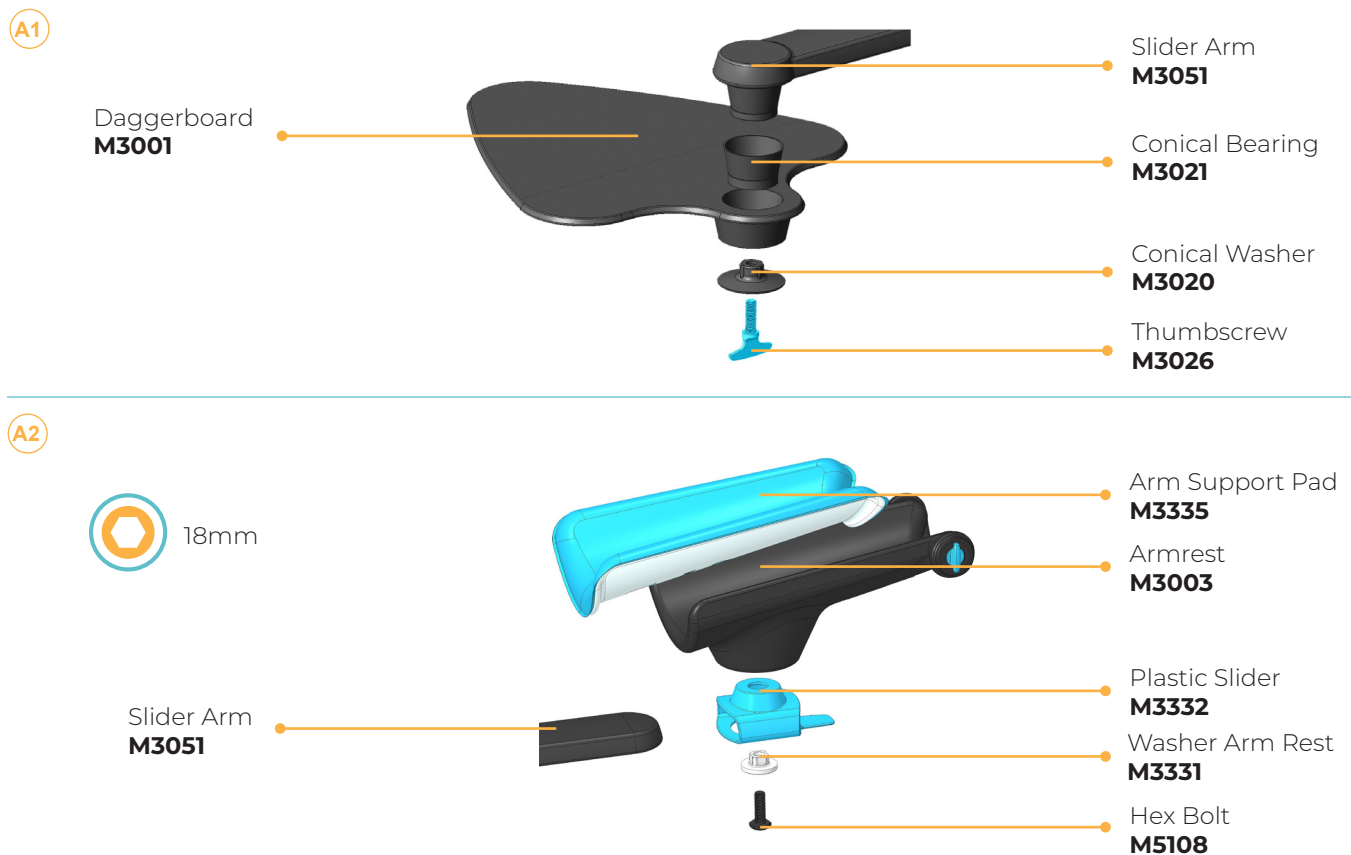

**A3**

Thumbscrew Wrist Pivot

**M3025**

Wrist Pivot Cone

**M3094**

Wrist Pivot

**M3052**



**A4**



18mm



Handle  
**M3072**

Washer Handle  
Spigot  
**M3030**

Hex bolt  
**M5108**

## STARTable

**BC**

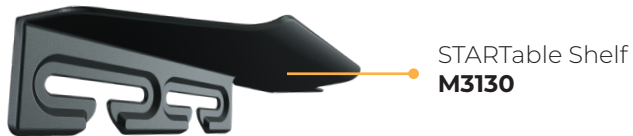

STARTable Shelf  
**M3130**



STARTable Shield  
**M3140**

## STARSupport

**D**



Left Arm Support  
Tube Assembly  
**M3333**

Swivel Clamp Assembly  
**M3059**

## Maintenance instructions:





[adeptmedicaltraining.com  
/product-maintenance-starsystem](https://adeptmedicaltraining.com/product-maintenance-starsystem)



## IR System

AM0180 - AM0500

### Component Codes

Product	Name	Code
	Extension Tray	M3334
	X-Ray Shield	AM0630
	Daggerboard	M3677

STARBoard  
(Refer to page 3-4)

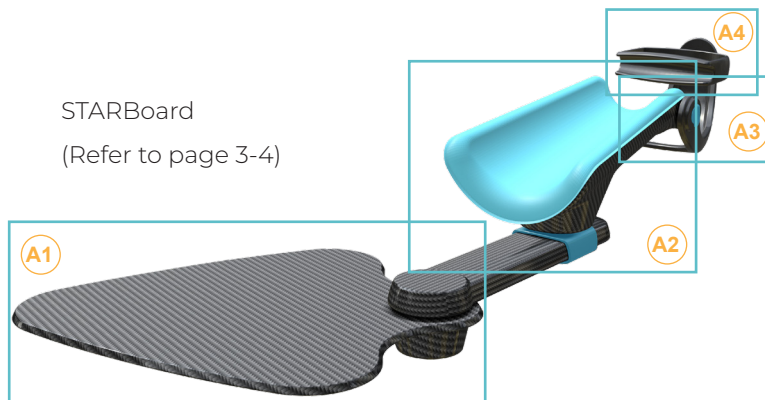



**ArmSure**  
AM0640 - AM0610

Component Codes

Component		Name	Code
	<b>A</b>	Arm Support	M5109
	<b>B</b>	Arm Strap x 10	AM0620
	<b>C</b>	Arm Support XR	M5101
	<b>D</b>	X-Ray Shield	AM0630



**MR Safe**  
**Overhead Arm Support**  
AM4000

Component Codes





Component		Name	Code
	<b>A</b>	Armrest Wing MR Safe	M5504
	<b>B</b>	Arm Strap x 10	AM0620
	<b>C</b>	Locking Leg Assembly MR Safe	M5505
	<b>D</b>	Daggerboard MR Safe	M5506

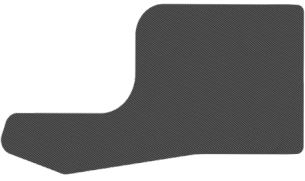

## Antegrade IR Platform

AM0440

### Component Codes

Component		Name	Code
	<b>A</b>	Antegrade Main Platform	M6500
	<b>B</b>	Base	M6521
	<b>C</b>	Leg	M3664
	<b>D</b>	Leg Extension	M3693

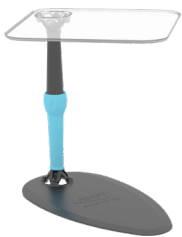

## Drape Support

AM1000

### Component Code

Product	Name	Code
	Drape Support	AM1000



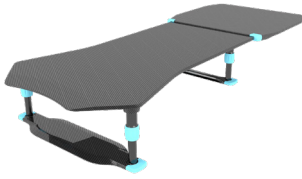



## Retrograde IR Platform

AM0400 - AM0410 - AM0420

### Component Codes



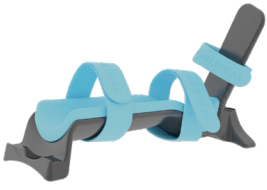



Component		Name	Code
	<b>A</b>	Retrograde Main Platform	M3660
	<b>B</b>	Front Base	M3662
	<b>C</b>	Rear Base	M3663
	<b>D</b>	Leg	M3664
	<b>E</b>	Leg Extension	M3693
	<b>F</b>	Extension	AM0410



## Lower Leg Support

AM3000

### Component Codes

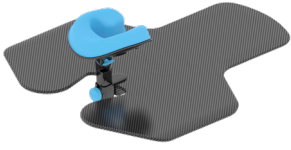

Component		Name	Code
	<b>A</b>	Foot Plate	M6511
	<b>B</b>	Leg Pad	M6512
	<b>C</b>	Support Base	M6516
	<b>D</b>	Leg Strap	M6513
	<b>E</b>	Foot Strap	M6514
	<b>F</b>	Table Strap	M6515



## Prone Support

AM0700

### Component Codes

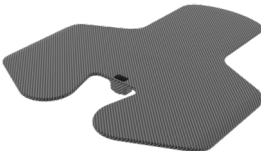
Component		Name	Code
	<b>A</b>	Face Pad	M6531
	<b>B</b>	Face Pad Support	M6532
	<b>C</b>	Adjustable Assembly	M6533
	<b>D</b>	Base Board	M6534



## Clinician Arm Support

AM0900

### Component Codes

Component		Name	Code
	<b>A</b>	Arm Support Pad	M3335
	<b>B</b>	Forearm Assembly	M9120
	<b>C</b>	Base Board Assembly	M9100

### Tube Assembly

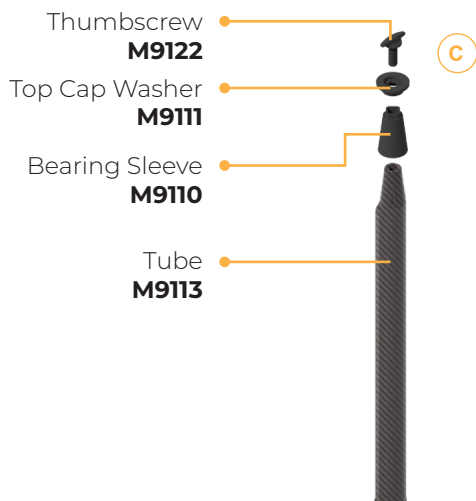

### Forearm Assembly (M9120)

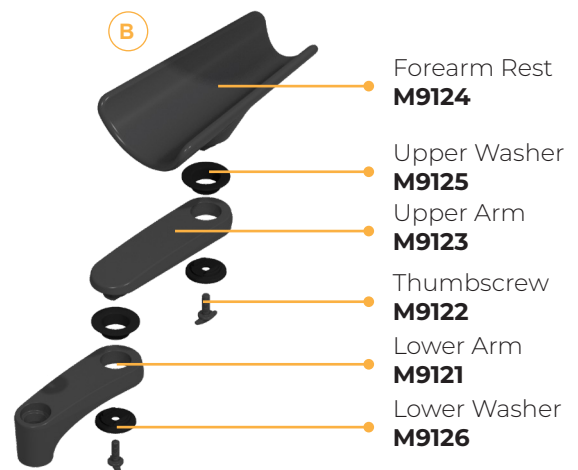





## Adducted Arm Scoop

AM1100

### Component Codes



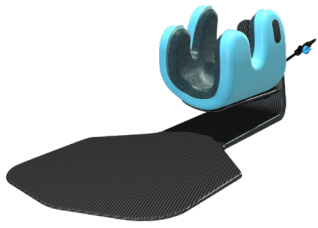

Component		Name	Code
		Adducted Arm Support x 1	M6555



## Head Immobiliser

AM0800

### Component Codes

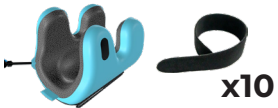
Component		Name	Code
	<b>A</b>	Base Board Assembly	M8000
	<b>B</b>	Base Board	M8100
	<b>C</b>	Hood Support	M8200
	<b>D</b>	Adjustable Assembly	M8300
 x10	<b>E</b>	Forehead Straps x 10	M8400
 x10	<b>F</b>	Hood Assembly + Forehead Straps x 10	AM0820

### Maintenance instructions:

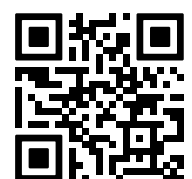
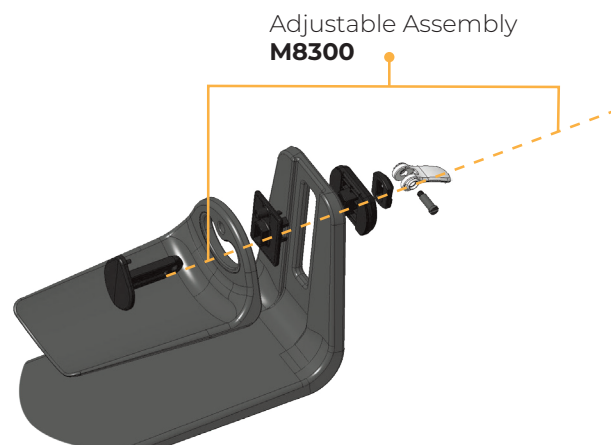
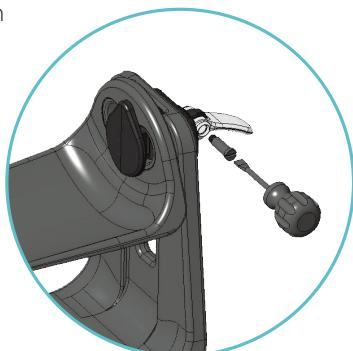

[adeptmedicaltraining.com  
/product-maintenance-headimmobiliser](https://adeptmedicaltraining.com/product-maintenance-headimmobiliser)